

CUSTOMER APPROVAL

NAME: _____

DATE: _____

IMPORTANT: BY SIGNING THIS DRAWING YOU ARE APPROVING IT AS IS. IF CHANGES ARE REQUIRED, A NEW DRAWING WILL BE REQUIRED.

NOTES:

1. DAY TANK PACKAGE INCLUDES 12 GAUGE STEEL, RUST PROOFED INTERIOR, PRIMED AND FINISHED PAINTED _____ W/ COVER. TANK PRESSURE TESTED FROM 3.5 TO 5.0 PSI.
2. APPROXIMATE DRY WEIGHT = 1025 LB.
3. FOR DETAILS ON THE SYSTEM 2000 PLUS SEE SEPERATE SPECIFICATIONS SHEET.
4. SEE PUMP SPECIFICATION SHEET FOR MORE DEFAULTS. SEE PUMP LIFT WORK SHEETS FOR ADDITIONAL INFORMATION ON PUMP HEAD AND LIFT.
5. OPTIONS (CHECK IF REQ'D)

- ___ 2" NPT NORMAL VENT (2252)
- ___ 4" NPT EMERGENCY VENT (2264)
- ___ OTHER _____
- ___ OTHER _____

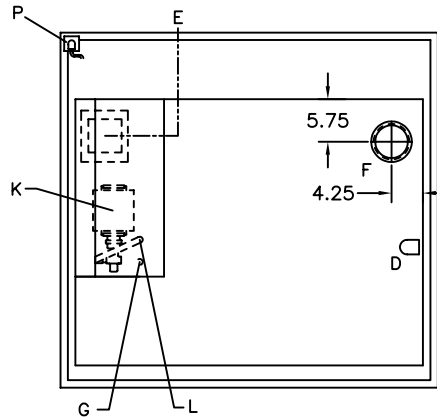

TOP VIEW

LET	FITTING DESCRIPTION
A	1" NPT FUEL RETURN
B	1" NPT OVERFLOW GRAVITY FEED TO MAIN TANK
C	2" NPT FOR NORMAL VENT
D	1" NPT ENGINE SUPPLY DIP TUBE
E	ELECTRICAL INPUT
F	4" NPT FOR EMERGENCY VENT
G	3/8" DIP TUBE FOR REVERSE PUMP (7" LONG)
H	1" NPT FOR DRAIN
J	SYSTEM 2000 PLUS - UL 508 (SEE NOTE #3)
K	MOTOR, 1/3HP, 115VAC, 1PH, 60HZ
L	3/8" NPT FITTING
M	PUMP, 2 GPM HIGH LIFT (SEE NOTE #4)
N	REMOVABLE NON-CONDUCTIVE COVER
P	RUPTURE BASIN ALARM
Q	RUPTURE BASIN - 150%
R	4 GPM REVERSE PUMP (SEE NOTE #4)

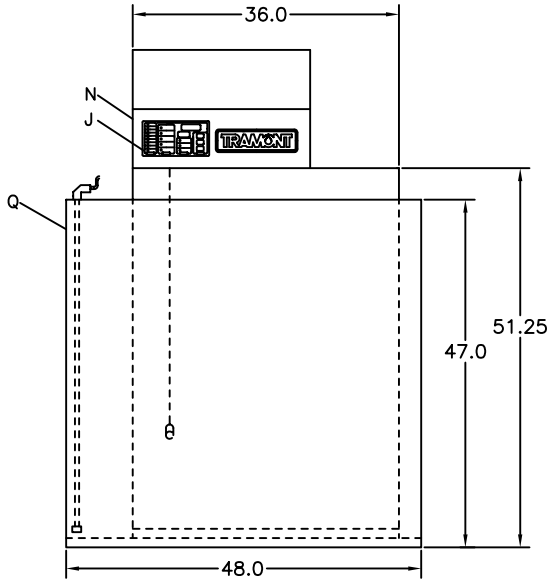

FRONT VIEW

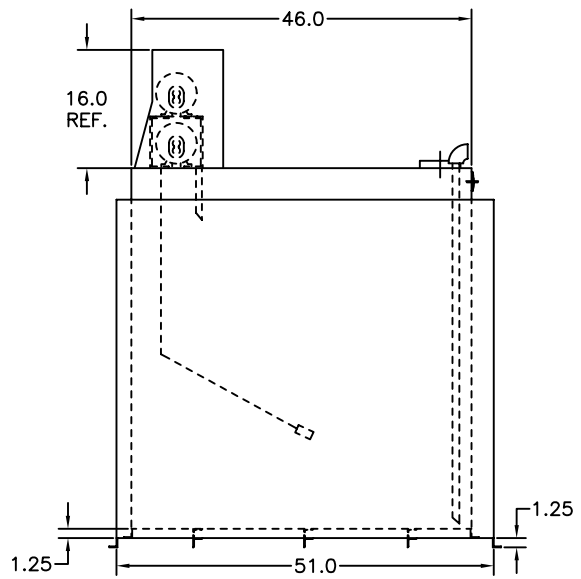

SIDE VIEW

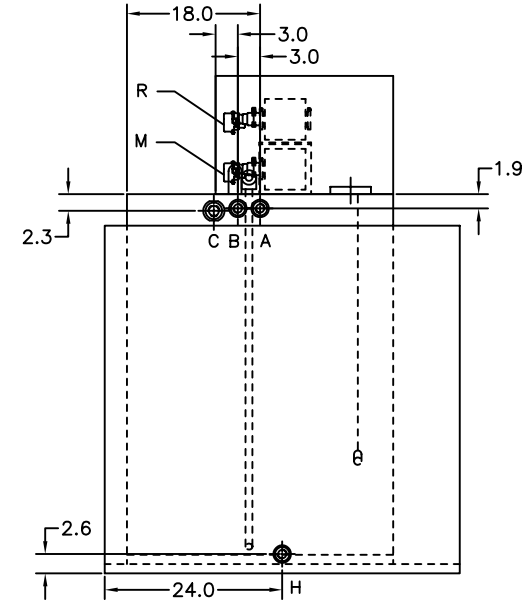

REAR VIEW

THIS DESIGN IS THE CONFIDENTIAL PROPERTY OF TRAMONT CORPORATION. FOR USE BY TRAMONT CORPORATION CUSTOMERS FOR SUBMITTAL PURPOSES ONLY. COPYRIGHT TRAMONT CORPORATION, 1998.

TRAMONT CORPORATION

DESCRIPTION: UTRS-350 DAY TANK WITH RUPTURE BASIN

LETTER	DATE	DESCRIPTION	NAME
A	03/28/02	START	JHP
CHANGE BLOCK (S)			

SCALE: NTS	FRACTIONS = +/- .5 .XX = +/- .125	DRAWN BY: JHP
DATE: 03/28/02	.X = +/- .250 .XXX = +/- .062	SALES: _____ ENG: _____

FOR: _____	DRAWING NO. 127-0650
------------	----------------------